

**Instruction 510-0844**  
**05-16-22**

© 2022  
by S&S® Cycle, Inc.

All rights reserved  
Printed in the U.S.A.

**S&S® Cycle, Inc.**

14025 Cty Hwy G  
Viola, Wisconsin 54664

Phone: 608-627-1497  
Technical Service Email: sstech@sscycycle.com  
Website: www.sscycycle.com



## **Installation Instructions: S&S® 4.320" Bore Cylinder and Piston Kits** **for M8 2017–2020**

### **DISCLAIMER:**

S&S parts are designed for high performance, closed course, racing applications and are intended for the very experienced rider only. The installation of S&S parts may void or adversely affect your factory warranty. In addition such installation and use may violate certain federal, state, and local laws, rules and ordinances as well as other laws when used on motor vehicles used on public highways, especially in states where pollution laws may apply. Always check federal, state, and local laws before modifying your motorcycle. It is the sole and exclusive responsibility of the user to determine the suitability of the product for his or her use, and the user shall assume all legal, personal injury risk and liability and all other obligations, duties, and risks associated therewith.

**NOT LEGAL FOR SALE OR USE IN CALIFORNIA ON ANY POLLUTION CONTROLLED MOTOR VEHICLE.**

Not legal for sale or use on any EPA pollution controlled motor vehicle.

### **SAFE INSTALLATION AND OPERATION RULES:**

Before installing your new S&S part it is your responsibility to read and follow the installation and maintenance procedures in these instructions and follow the basic rules below for your personal safety.

- Gasoline is extremely flammable and explosive under certain conditions and toxic when breathed. Do not smoke. Perform installation in a well ventilated area away from open flames or sparks.
- If motorcycle has been running, wait until engine and exhaust pipes have cooled down to avoid getting burned before performing any installation steps.
- Before performing any installation steps disconnect battery to eliminate potential sparks and inadvertent engagement of starter while working on electrical components.
- Read instructions thoroughly and carefully so all procedures are completely understood before performing any installation steps. Contact S&S with any questions you may have if any steps are unclear or any abnormalities occur during installation or operation of motorcycle with a S&S part on it.
- Consult an appropriate service manual for your motorcycle for correct disassembly and reassembly procedures for any parts that need to be removed to facilitate installation.
- Use good judgment when performing installation and operating motorcycle. Good judgment begins with a clear head. Don't let alcohol, drugs or fatigue impair your judgment. Start installation when you are fresh.
- Be sure all federal, state and local laws are obeyed with the installation.
- For optimum performance and safety and to minimize potential damage to carb or other components, use all mounting hardware that is provided and follow all installation instructions.
- Motorcycle exhaust fumes are toxic and poisonous and must not be breathed. Run motorcycle in a well ventilated area where fumes can dissipate.

### **IMPORTANT NOTICE:**

Statements in this instruction sheet preceded by the following words are of special significance.



**WARNING**

Means there is the possibility of injury to yourself or others.

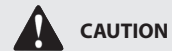

**CAUTION**

Means there is the possibility of damage to the part or motorcycle.

**NOTE**

*Other information of particular importance has been placed in italic type. S&S recommends you take special notice of these items.*

### **WARRANTY:**

All S&S parts are guaranteed to the original purchaser to be free of manufacturing defects in materials and workmanship for a period of twelve (12) months from the date of purchase. Merchandise that fails to conform to these conditions will be repaired or replaced at S&S's option if the parts are returned to us by the purchaser within the 12 month warranty period or within 10 days thereafter.

In the event warranty service is required, the original purchaser must call or write S&S immediately with the problem. Some problems can be rectified by a telephone call and need no further course of action.

A part that is suspect of being defective must not be replaced by a Dealer without prior authorization from S&S. If it is deemed necessary for S&S to make an evaluation to determine whether the part was defective, a return authorization number must be obtained from S&S. The parts must be packaged properly so as to not cause further damage and be returned prepaid to S&S with a copy of the original invoice of purchase and a detailed letter outlining the nature of the problem, how the part was used and the circumstances at the time of failure. If after an evaluation has been made by S&S and the part was found to be defective, repair, replacement or refund will be granted.

### **ADDITIONAL WARRANTY PROVISIONS:**

- (1) S&S shall have no obligation in the event an S&S part is modified by any other person or organization.
- (2) S&S shall have no obligation if an S&S part becomes defective in whole or in part as a result of improper installation, improper maintenance, improper use, abnormal operation, or any other misuse or mistreatment of the S&S part.
- (3) S&S shall not be liable for any consequential or incidental damages resulting from the failure of an S&S part, the breach of any warranties, the failure to deliver, delay in delivery, delivery in non-conforming condition, or for any other breach of contract or duty between S&S and a customer.
- (4) S&S parts are designed exclusively for use in Harley-Davidson® and other American v-twin motorcycles. S&S shall have no warranty or liability obligation if an S&S part is used in any other application.

**Kit Contents:**

- Piston kit.....qty 1
- 4.320" bore pistons.....qty 2
- 0.927" piston pins.....qty 2
- Piston pin clips .....qty 4
- Ring packs.....qty 2
- 4.320" bore cylinders.....qty 2
- MLS style head gaskets.....qty 2
- Cylinder base gaskets .....qty 2
- Cylinder dowels .....qty 4
- Exhaust gaskets .....qty 2

**Special Tool Requirements:**

- Harley-Davidson® service manual for the specific model you are working on
- Piston ring compressor
- Piston ring expander
- Piston ring end gap filing tool
- Feeler gauges
- Torque wrench

**Additional Parts Needed:**

- S&S head bolt kit PN 900-1006 or equivalent

**General Information**

- Thoroughly read and understand all the instructions before starting installation.
- Basic specifications for each bore and stroke combination:

Bore	Stroke	Piston deck height	Piston dish volume (cc)	Head gasket thickness	Resulting static CR
4.320"	4.375"	1.143"	-7.5	0.030"	11:1
4.320"	4.500"	1.080"	-10.5	0.030"	11:1
4.320"	4.625"	1.080"	-10.5	0.040"	11:1

- The cutouts on the top of the piston are large enough to accommodate oversized valves.
- Pistons are front and rear specific. The piston location is denoted by "Front" or "Rear," the orientation is dictated by the word "Cam." **See Picture 1** for correct orientation as viewed from the top of the engine facing forward.

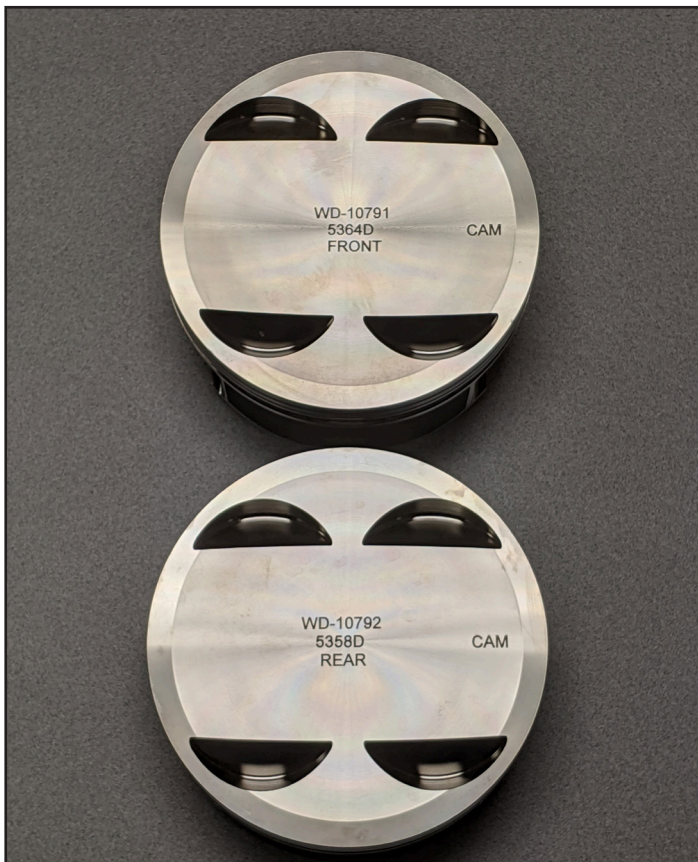

**Picture 1**

- The pistons are machined to provide the correct running clearance when cylinders are bored to the nominal size of 4.320". In other words, the clearance is built into the piston diameter. Piston to cylinder clearance is 0.003" to 0.0035" prior to skirt coating. Piston skirt coating is approximately 30 micron. Any cylinder measurements must be taken with the cylinder in torque plates with bolts tightened at the correct torque to simulate conditions in an assembled engine.
- In all cases it is the engine builders responsibility to confirm proper clearances when assembling an engine. This is especially critical with performance components such as large valves, high performance heads and high lift camshafts.
- In addition to clearances mentioned, 0.060" valve to piston clearance must be confirmed.

**CAUTION**

**Failure to follow instructions and perform required clearance, installation, and/or break-in procedures may result in damage to pistons and or other engine components not covered under warranty. The proper break-in procedure is in Section 7 of these instructions.**

**Disassembly and Inspection**

1. Refer to the Harley-Davidson® manual for your specific motorcycle for the correct disassembly procedure.
2. The engine should be disassembled to the short block i.e. induction system, exhaust system, cylinder heads, cylinders, and pistons should be removed.
3. Check cylinder studs to make sure they have not backed out during disassembly. To do this, use an appropriate stud socket or double nut technique and tighten to 15 ft-lbs. If a cylinder stud is removed, clean the threads and apply red loctite. Re-install the stud and torque to 15 ft-lbs.

**Installation and Reassembly**

**Ring Identification:**

- Both the top and second rings have a dark gray finish and are marked with an "M". Use the following information to clearly identify the two.



- The top ring has a plasma moly face which has a bright finish, install with the "M" facing up.
- The second ring is a Napeir style ring with a 1 degree tapered face. The face of this ring has a dark gray finish, install with the "M"



facing up. To further identify the ring, look for the groove on the bottom outside of the ring.

- See the pictures below to clearly identify the Napier style 2nd ring.



**Napier 2nd ring - Bottom side shown**

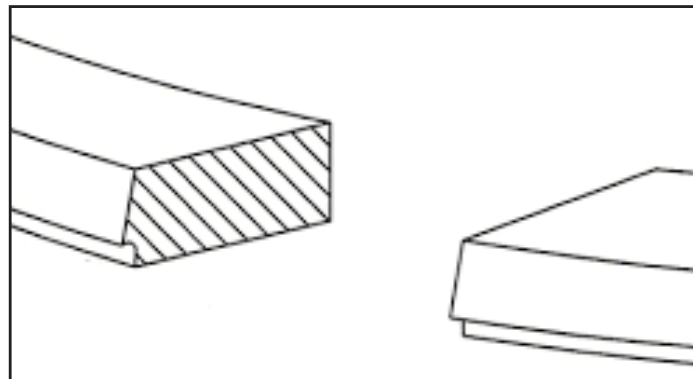

**Napier style 2nd ring - cross section shown.  
Install with the hooked groove pointing down.**

**Setting Ring End Gaps**

**NOTES:**

- Important! The gap of the second ring should be larger than the top ring; this will help keep the top ring seated for improved performance.
- Each ring should be fitted to the particular cylinder in which they will be installed.
- Oil rails can be installed without adjusting the end gap. The minimum gap should be 0.010"
- Never alter the end gap of the oil expander ring.
- Always install the ends of the expander facing up **as shown in Figure 1**

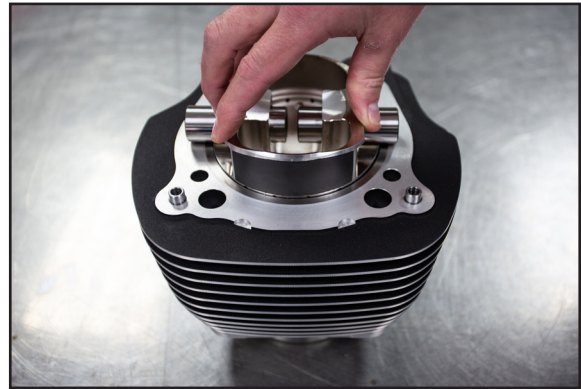

**Figure 1**

- Thoroughly wash cylinders with hot soapy water, then wash with brake cleaner and wipe with a clean white towel. Repeat until the towel does not show evidence of debris and apply a

light coat of oil immediately.

- Check the ring end gap by placing the ring into the cylinder. Use a piston or caliper to ensure that the ring is placed squarely in the bore. **See Picture 2.**



**Picture 2**

- Measure the ring end gap with a feeler gauge. **See Picture 3.**



**Picture 3**

- See Table 1** for proper end gap measurement. If an adjustment to the gap must be made, use a proper ring end gap filing tool.

Ring End Gap		
Top Ring	Second Ring	Oil Ring
.024" to .028"	0.028" to 0.032"	0.010" Min Do not adjust
<i>Note: For racing applications adjust ring end gap to the high end of the specification</i>		

**Table 1**

- e. Always file from the ring face towards the inside diameter to avoid damaging the face coating.
- f. Remove material from only one end of the ring.
- g. Ensure that ring end gaps are square.
- h. Remove sharp edges and burrs.
- i. Recheck gap measurement and adjust as necessary.
- j. Repeat procedure with the other rings.

#### 4. Piston Ring Installation

- A. Install the piston rings in the following order
  1. Oil ring expander (ends must face up as shown in Figure 1).
  2. Oil ring rails
  3. 2nd ring. Dark gray finish with Napier cut. Letter "M" faces up. Groove on bottom outside of the ring.
  4. Top ring. Dark gray finish with shiny face. Letter "M" faces up.
- B. Install the oil ring expander in the bottom groove of the piston. Make sure the ends of the expander ring are butted together and not overlapping. **See Figure 1.** If the tips are overlapped, excessive oil consumption will occur. Orient the expander end gap such that it can be viewed as it enters the cylinder. **See Picture 4.**

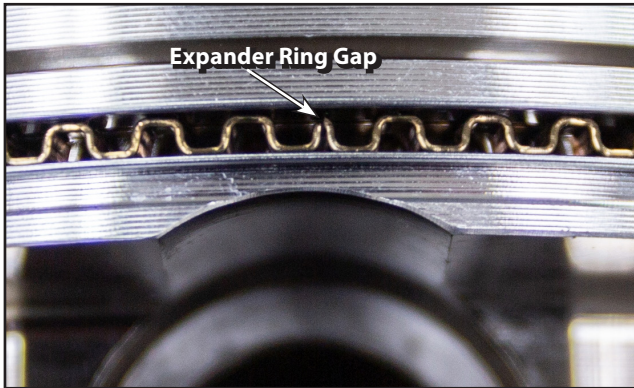

**Picture 4**

- C. Install oil rails. The oil rails are the thinnest of all the rings. Either side can be placed up. Install the rails into the groove by hand. Install one rail above the expander, and one below.
- D. Install the 2nd ring with the letter "M" facing up. The Napier groove will face down.
- E. Install the top ring with the Letter "M" facing up.
- F. Orient the gaps according to **Picture 5.**

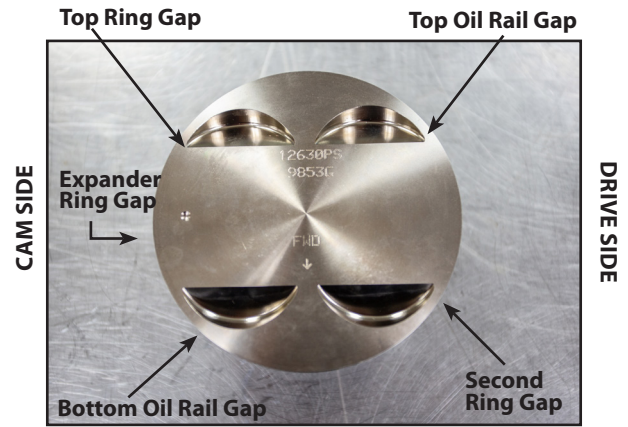

**Picture 5**

#### 3. Piston Installation

##### NOTES

- *Pistons are Front and Rear specific. See Picture 1.*
- *Check piston pin to connecting rod clearance. Clearance should be between 0.0007" and 0.002"*



**The pistons must be oriented as shown in Picture 1.**

- a. Place rubber tubing over the cylinder studs to prevent damage to the pistons and rings during assembly.
- b. Place a clean sheet of plastic over the crankcase openings to prevent anything from dropping into the crankcase.
- c. Install one of the piston pin clips into each of the pistons.
- d. Lightly oil the piston pin, piston pin bore, and upper connecting rod bushing with assembly lube.
- e. Hold the piston over the connecting rod with the piston facing the correct direction and the piston pin bore and upper bushing bores lined up.
- f. Install the piston pin through the piston pin bore and through the connecting rod bushing until the pin contacts the clip.
- g. Install the other piston clip. Ensure that both clips are fully seated.
- h. Repeat procedure for the other piston.

#### 4. Cylinder Installation

**NOTE:** *The cylinders are NOT identical and must be installed in the correct location. The rear cylinder has additional clearance machining in the pushrod area. The front cylinder does not.*

- a. Bring the front cylinder to TDC.
- b. Apply a light coating of oil to the piston and rings.
- c. Install base gasket so you can read the "UP" and the cut out edge faces the lifter cover.
- d. Verify that the ring gaps are orientated correctly, **refer to Picture 5.**
- e. Remove the rubber tubing from the cylinder studs.
- f. Compress ring pack by using a suitable ring compressor. If possible, position the ring compressor so that you can see the oil expander gap during installation. **See Picture 4.**
- g. Install cylinder on piston, making sure not to overlap oil ring

expander.

- h. Remove ring compressor.
- i. Remove plastic sheeting covering the crankcase.
- j. Slide the cylinder down until it seats against the crankcase.
- k. Rotate the engine until the rear cylinder is at TDC.
- l. Repeat procedure for the rear cylinder.

### 5. Cylinder Head Installation

**NOTE:** The provided MLS head gasket, **Picture 6**, can be used on both oil cooled and liquid cooled cylinder heads.



**Picture 6**

- A. Check surfaces for flatness and imperfections, an excessively rough finish may cause gasket failure.
- B. Install cylinder dowels. They are designed to be a slip fit in the cylinder.
- C. Clean all threads and lubricate with clean oil. Lubricate the underside flange of the head bolts with clean oil.
- D. Locate the embossed fire ring on center layer of the multilayer head gasket. Install the head gasket with this raised ring facing the cylinder. **See Picture 7.**

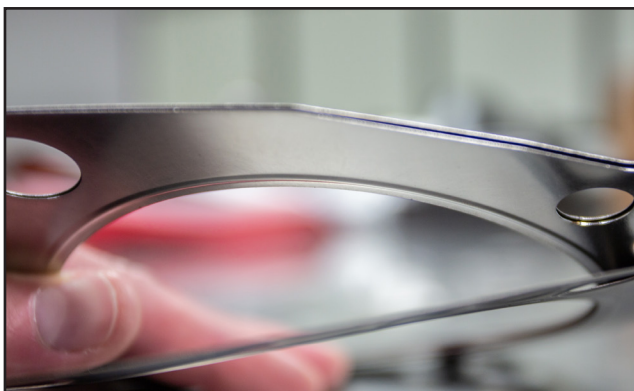

**Picture 7**

- E. Once the gasket is in place, make sure that it fits the bore. The gasket should not hang into the bore or combustion chamber area.
- F. If using cylinder heads other than stock, check the brass rivets of the MLS gaskets to ensure the rivets do not interfere with the sealing surface in any way.

### ⚠ CAUTION ⚠

**New head bolts must be used. S&S head bolt kit PN 900-1006 is recommended. The following torque sequence must be followed. Failure to do so will result in engine failure not covered under warranty.**

- G. Tighten the head bolts according to the following procedure, start with the front head then the rear head.
  - i. Tighten each bolt finger tight using the sequence in **Figure 2.**
  - ii. Tighten each bolt to 10 ft-lbs using the same sequence.
  - iii. Tighten each bolt to 20 ft-lbs using the same sequence.
  - iv. Tighten each bolt to 30 ft-lbs using the same sequence.
  - v. Fully loosen each bolt ¼ turn at a time in the reverse sequence.
  - vi. Tighten each bolt finger tight using the sequence in **Figure 2.**
  - vii. Tighten each bolt to 10 ft-lbs using the same sequence.
  - viii. Tighten each bolt to 20 ft-lbs using the same sequence.
  - ix. Tighten each bolt to 25 ft-lbs using the same sequence.
  - x. Tighten each bolt to 30 ft-lbs using the same sequence.
  - xi. Tighten each bolt to 35 ft-lbs using the same sequence.
  - xii. Final tighten each bolt to 45 ft-lbs using the same sequence.
  - xiii. Wait 15 minutes then recheck each bolt at 45 ft-lbs using the same sequence.

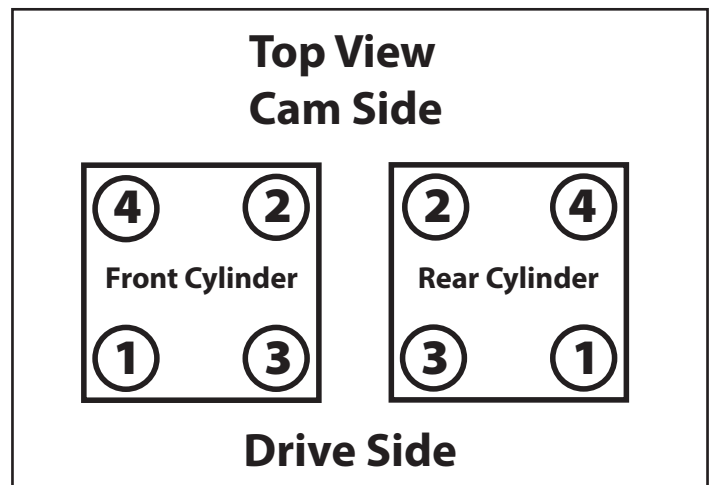

**Figure 2**

### 6. Final Assembly

Assemble the remaining items according to the Harley-Davidson® service manual specific for your motorcycle.

### 7. Tuning

S&S big bore kits increase the displacement and compression ratio of your engine. The fuel and ignition systems must be calibrated for these changes before the engine is driven and break-in is attempted. Fuel injected engines must be tuned using an aftermarket tuner.

### Break-in Procedure

#### GENERAL BREAK IN NOTES

- Remember that these are air-cooled engines. Sufficient air movement is



required to keep engine temperatures within safe operating limits.

- Avoid heavy traffic and congestion or extended idle periods whenever possible.
- V-twin performance engines are designed for, and happiest when running between 2750–3500 rpm.
- Today's heavier bikes and taller gearing can easily push a high performance engine into a lugging condition which increases loads on engine components, causes detonation, builds excessive heat, and increases fuel consumption. If the engine does not accelerate easily when given some throttle, downshift to a lower gear.
- All engines benefit from a warm-up period any time they are started, allow to reach operating temperature before being subjected to heavy loads or quick throttle revs.

#### **BREAK-IN**

1. Initial start-up. Run engine approximately one minute at 1250–1750 rpm. DO NOT crack throttle or subject to any loads during this period as head gaskets are susceptible to failure at this time. During this time, check to see that oil pressure is normal, that oil is returning the oil tank, and that no leaks exist.
2. Shut off the engine and thoroughly check for any leaks or other problems. Let the engine cool to the touch.
3. After the engine has cooled, start up again and allow the engine to build some heat. The engine should be run no longer than three to four minutes. When the cylinders become warm/hot to the touch (approximately 150° F) shut the engine down and let it cool to room temp. Follow the same cautions as for the initial start-up, and continue to check for problems.
4. First 50 Miles
  - a. Street: Ride normally, do not lug the engine. Avoid high heat conditions and vary the RPM while riding. No stop and go traffic, extended idle periods, or high load or high RPM conditions. Max of 3,500 rpm or 60 mph.
  - b. Dyno: A chassis dynamometer can be used to put the first 50 miles on a new engine. See the notes and procedure below for chassis dyno break-in.
5. 50–100 Miles: Ride normally, do not lug the engine. Avoid high heat conditions, no stop and go traffic or extended idle periods. Limited short bursts of throttle can aid in ring seating from this point forward during the break-in, but avoid continuous high speed or load conditions. Max of 4,250 RPM or 70 mph.
6. 100–500 Miles: Avoid lugging the engine and high heat conditions. Max of 5,000 rpm. Change oil at 500 miles.
7. 500–1,000 miles - Ride bike normally, but avoid continuous high load operation and high heat conditions.
8. From 1,000 miles on: Break-in is complete, enjoy!

#### **NOTES FOR COMPLETING INITIAL 50 MILE BREAK-IN ON A CHASSIS DYNO**

- If running the bike on the dyno it is critical that engine temperatures are monitored, AFR is kept between 12.5–14.7 and the engine is not overheated. Fans must be used to keep the engine cool.

- A load must be placed on the engine to properly seat the rings. Running a new engine continually with no load will result in cylinder glazing and poor ring seal. The engine should be loaded to simulate close to the weight of the bike, a load of 10–15% on a DynoJet® 250i is usually sufficient. It is not recommended to use an inertia only dyno to break-in an engine as no load can be placed on the engine.

#### **Dyno Break-In Procedure-**

1. Follow the same procedure outlined above for initial start-up and heat cycling the engine.
2. Run the bike for 25 miles on the dyno under varying speeds and loads while going up and down through the gears. Keep engine RPM below 3,500 RPM but do not lug the engine. The dyno must be operated so the engine runs under a load roughly equal to the power needed to move the bike down the road, this would be about 12 hp at 55 mph. Keep engine head temperatures below 300°F at the temp sensor or surface of the head. Stop and cool the engine if needed.
3. Allow the engine to cool down to room temperature
4. Run the bike for 25 more miles (50 miles total) under varying speeds, loads, gears as before. Make sure there is some load on the engine. Keep engine speed below 4,250 rpm but do not lug the engine. Limited short bursts of throttle can aid in ring seating. Keep engine head temperatures below 320°F at the temp sensor or surface of the head.
5. After the first 50 miles on the dyno, it is recommended the normal break-in schedule be followed under normal riding conditions on the street. See Step 5 above.

#### **OIL RECOMMENDATIONS**

S&S® Cycle recommends the use of S&S 20W-50 synthetic based V-Twin Engine Oil.

Break-in can be performed with either synthetic or petroleum based oil. Regardless of what type of oil you select, be sure to only use oil specifically designated for use in an air cooled motorcycle engine.