

## INSTALLATION INSTRUCTIONS: HARLEY-DAVIDSON SOFTAIL BIG RADIUS 2-INTO-2 PART# 46069

Congratulations, you have purchased the finest exhaust system available for your motorcycle. Your Vance & Hines exhaust is designed and crafted for performance, quality, and style. Please follow the instructions below, check exhaust system for missing or damaged parts and if you need any assistance please contact our technical support line (562) 921-7461.

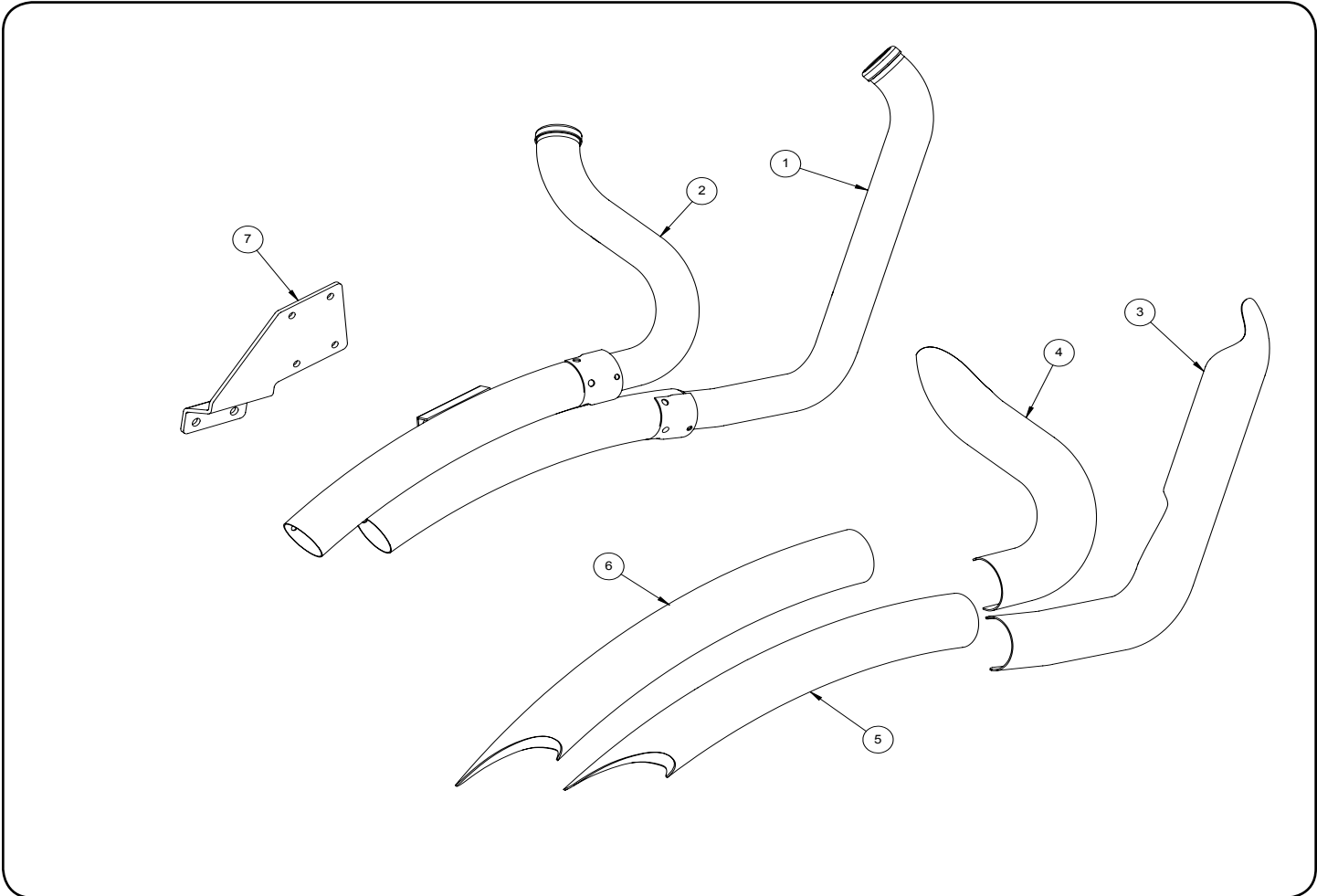

### PARTS LIST

NO.	Part NO.	Description	Qty.
1	D438FP	Front Head Pipe	1
2	D439FP	Rear Head Pipe	1
3	D438HP	Front Heat Shield	1
4	D439HP	Rear Heat Shield	1
5	D322HP	Front Muffler Heat Shield	1
6	D323HP-S	Rear Muffler Heat Shield	1
7	352-P	Mount Bracket	1
8	A272HW	1.31-2.25 In. Hose Clamp	4
9	A270HW	.81-1.75 In. Hose Clamp	5
10	A285HW	1/2-20 x 3 In. SHCS	1
11	A101HW	3/8-16 x 2.5 In. SHCS	1
12	A195HW	Dog Bone Nut Plate	2
13	D101ST-P	Footpeg Spacer	1
14	D110ST-P	Spacer	1
15	A290HW	3/8-16 x 3/4 Flange Screw	2
16	A240HW	5/16-18 x 5/8 Flange Screw	4
17	A644ST	18-12mm O2 Adaptor	2
18	A121HW	18 x 1.5 x 10mm Plug	2
19	A213HW	18 x 24mm OD Copper Washer	2

## HARDWARE

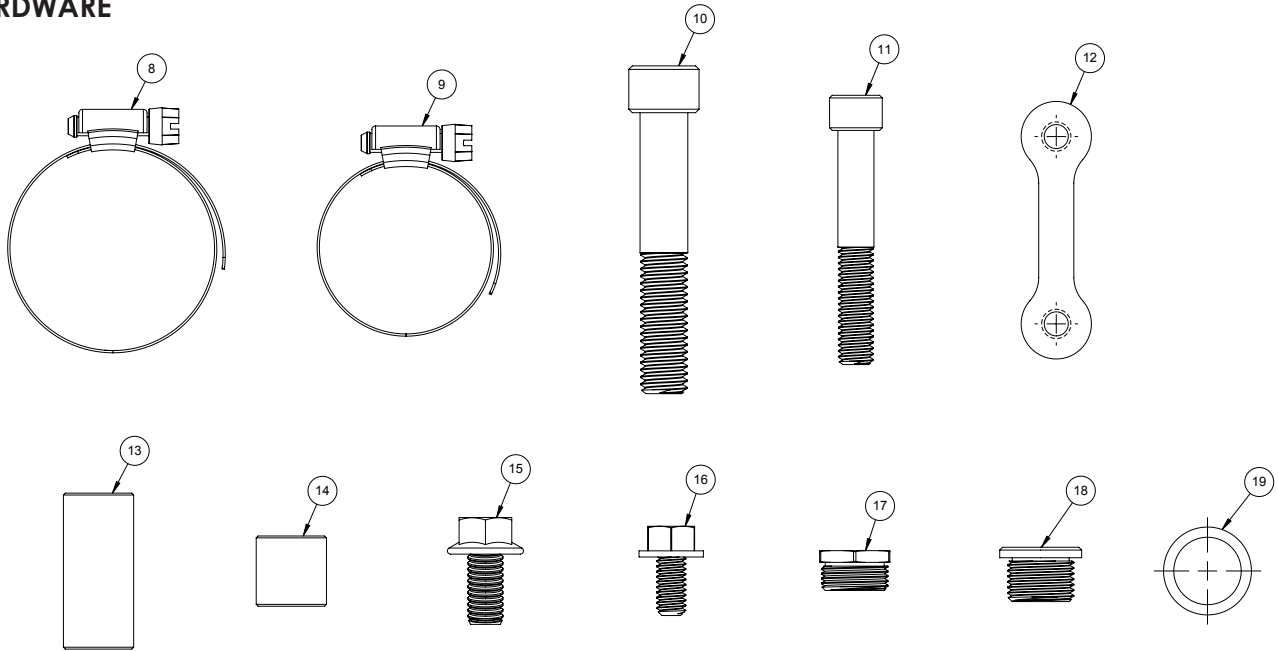

## TOOLS REQUIRED

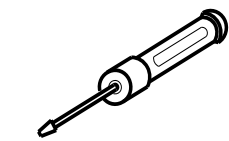

Flat blade screwdriver  
#3 Phillips Head

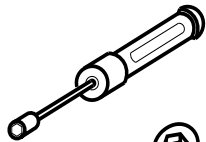

5/16" Nutdriver

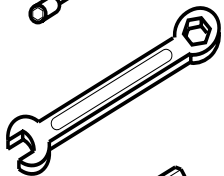

1/2", 9/16", 3/4", 7/8"  
or 22mm & 14mm  
Combination wrenches

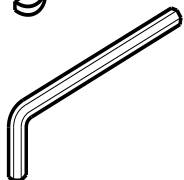

3/16" Allen wrench



T45 & T50 Torx Wrenches

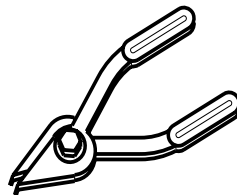

Snapping pliers

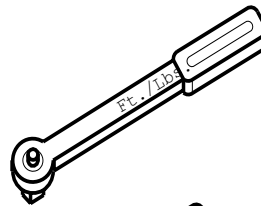

Ft./Lb. Torque wrench

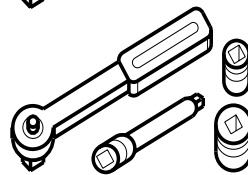

3/8" Ratchet &  
Extensions, 1/2" & 9/16"  
19mm Sockets  
3/4" Deep Socket

## STOCK EXHAUST REMOVAL

1. Rear O2 sensor, locate the O2 sensor connector, unplug the connector from the main harness and feed the wire through the frame to free it from the motorcycle. Pay attention to the wire routing for reinstallation. NOTE: For 2007 to 2011 models the connector is located under the oil tank, on the right side. For 2012 & Later models the connector is located under the seat, remove both the seat and the battery for access.
2. Front O2 sensor, Locate the O2 sensor connector at the front of the motorcycle, unplug connector from harness, and free the sensor lead from the motorcycle. NOTE: For 2007 to 2011 Models, open the plastic cover above the rectifier to gain access to the sensor plug. Cut the cable ties holding the sensor wire to frame.
3. On models with floor boards, loosen the right hand floor board mounting bolts to gain clearance for exhaust removal and installation.
4. On FLSTF, FXS and FLSTN and FXSTD, you will need to remove the right side passenger footpeg and hanger, as this is attached to the exhaust mount bracket. Leave the footpeg and hanger off, additional reinstallation instructions to follow.
5. Unbolt the carriage bolt and clamp attached to the bracket located under the right side transmission cover.
6. Loosen the heat shield clamps on both front and rear exhaust pipes.
7. Remove the two mounting nuts from each head pipe.
8. Remove the nuts attaching the exhaust mounting bracket to the frame.
9. Remove the exhaust system and set it aside. Assistance may be required.
10. Carefully remove the O2 sensors from the stock head pipes.
11. Remove the stock mounting bars, brackets and/or studs.
  - A. PRE 2000 Models: Remove the lower mounting bar. Remove the right side 1/4" bolt which holds the lower fender in place to allow removal of the right passenger foot peg. Place the motorcycle on its side stand and loosen the swing arm pivot bolt nut. Position a floor jack under the right hand frame tube just below the swing arm pivot bolt. Using assistance, carefully raise the jack just enough to take the weight off the swing arm bolt and remove the swing arm pivot bolt and the stock upper mounting bar. Replace the swing arm pivot bolt and torque to 135 FT/LB. Re-install the right passenger foot peg using the 1/2"x3" capscrew with the 1 5/8" spacer and 1/4" bolt to secure fender.
  - B. 2000 & Later Models: Using a T50 Torx driver, remove the three mounting bolts and mounting bar. Two of the T50 bolts are visible, the third also attaches the right hand passenger peg and is accessed by removing the foot peg. Re-install the foot peg using the 3/8"x2 1/2" capscrew with the 3/4" spacer.
12. Carefully remove exhaust port flanges and circlips from the stock exhaust system using snapping pliers. NOTE: Replace bent or damaged circlips.
13. Check condition of exhaust gaskets and replace if worn or damaged.

## VANCE & HINES EXHAUST INSTALLATION

1. Install bracket (stamped 352-P) (supplied) using the two lower holes in the frame below the right passenger footpeg, using two 3/8" x 3/4" flange bolts (supplied) (**Figure 1**).
2. Remove head pipes and heat shields from protective packaging. Place each heat shield on a non-abrasive surface such as a blanket or carpet. Using a pencil only, mark the outside edge of each heat shield to show the location of the hose clamp mounting clips (**Figure 3**).
3. Lay head pipes into head pipe heat shields (**Figure 2**) and loosely install the #20 hose clamps (supplied) into mounting clips (**Figure 3**). **NOTE:** Screw head should be accessible when system is installed on motorcycle for adjustment purposes (**Figure 4**). Do not tighten at this time.
4. Apply a small amount of anti-seize compound to the threads of the O2 sensors removed from the stock head pipes and install them into the new pipes. **NOTE:** 2007 to 2011 models or models using 18mm wideband oxygen sensors install sensor directly into the head pipe. 2012 to 2014 models install supplied 18mm to 12mm oxygen sensor adapter then install 12mm oxygen sensors (Grey connector into front head pipe, Black connector into rear head pipe.) All models not using oxygen sensors install 18mm plug with the copper crush washer.
5. Install circlips and flanges from stock system onto both new head pipes (**Figure 5**).
6. Using stock flange nuts, carefully install head pipes onto motorcycle. Do not tighten at this time.
7. Use the nut plates and 5/16" x 5/8" flange bolts (supplied) to attach the pipes to the bracket (**Figure 6**). Do not tighten at this time.
8. Align pipes on motorcycle so the gap between the two muffler bodies is consistent from front to rear (**Figure 7**). Tighten the exhaust port flange nuts, 5/16" x 5/8" flange head bolts (supplied) and the 3/8"x 3/4" flange head bolts (supplied) attaching the bracket to the frame.
9. Using the #28 hose clamps (supplied) install the muffler heat shields beginning with the D322HP on the front head pipe followed by the D323HP (Chrome badge) on the rear head pipe. Screw heads should be accessible for adjustment purposes (**Figure 4**). Do not tighten at this time.
10. Adjust all heat shields for the best alignment at the seam where they meet (**Figure 8**) and tighten all the hose clamps.
11. Route O2 sensor wires away from hot areas of the motorcycle. Plug the O2 sensor wires back into the wiring harness: For 2012 & Later, feed wire for the rear O2 sensor (Black) around the frame and under the seat. Re-install the battery, plug the sensor into the stock wiring connector. Feed connector for the front oxygen sensor (Gray) around the frame and into the holder on the frame behind the rectifier. Plug the sensor into the stock wiring connector. For 2007 to 2011 models, feed the wire for the front oxygen sensor around and into the plastic holder on the frame. Plug the sensor into the stock wiring connector. Snap the plastic holder closed to hold the connector in place. Install a new nylon cable tie to hold the wires onto the frame in the original location. Feed connector for the rear oxygen sensor around the frame under the oil tank on the right hand side. Plug the sensor into the stock wiring connector.
12. Re-tighten floor board mounting bolts on models equipped.
13. Be sure to tighten all hardware before starting motorcycle.
14. After installation and before starting the motorcycle, completely clean pipes and mufflers with warm soapy water and a clean soft cloth that will not leave a residue. **NOTE:** Any residue, oil, or fingerprints will stain the chrome when the metal heats up.

## EXHAUST CARE

1. When installing a new set of black pipes, make sure your hands are clean and free of oil. After installation, thoroughly clean pipes with warm soapy water and a soft cloth. Dry with clean towel to remove any residue before starting the motorcycle. Do NOT use anything abrasive to clean pipes.
2. Avoid long periods of idling as this can cause discoloration.
3. Intake leaks can cause the engine to run lean and overheat, this could lead to discoloration.
4. Make sure there are no exhaust leaks at the junction of the exhaust pipes and cylinder head. We recommend replacing gaskets if they are worn.

**FIGURE 1**

Install 352-P  
Bracket

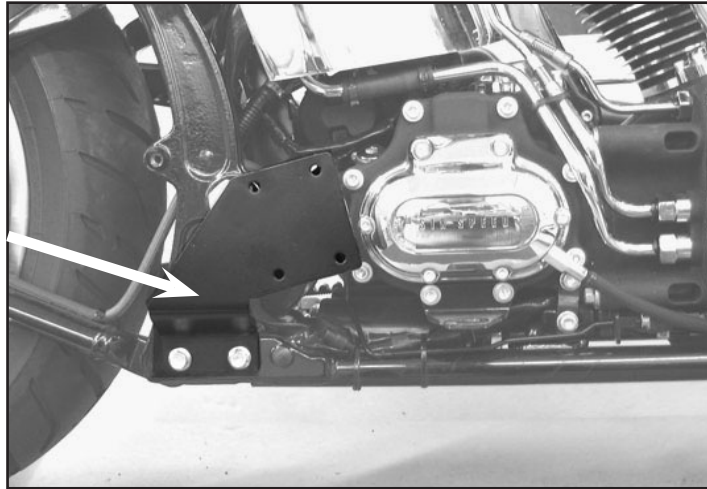

**FIGURE 2**

Lay head pipes  
into heat shields



**FIGURE 3**

Mark mounting clip  
locations

Install hose  
clamps

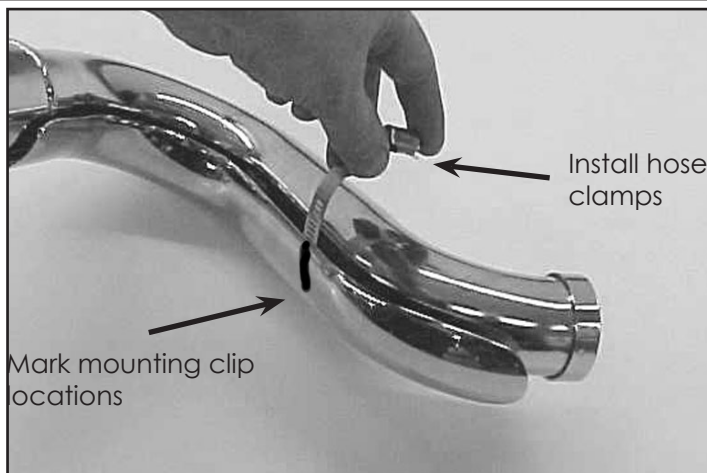

**FIGURE 4**

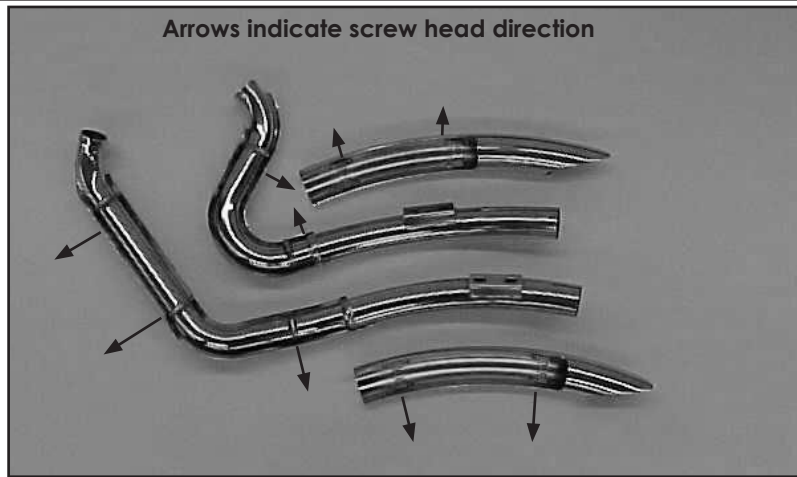

**FIGURE 5**

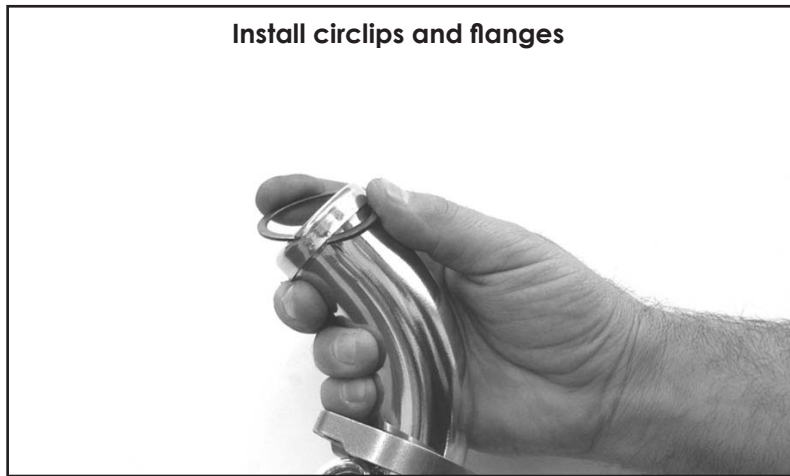

**FIGURE 6**



**FIGURE 7**

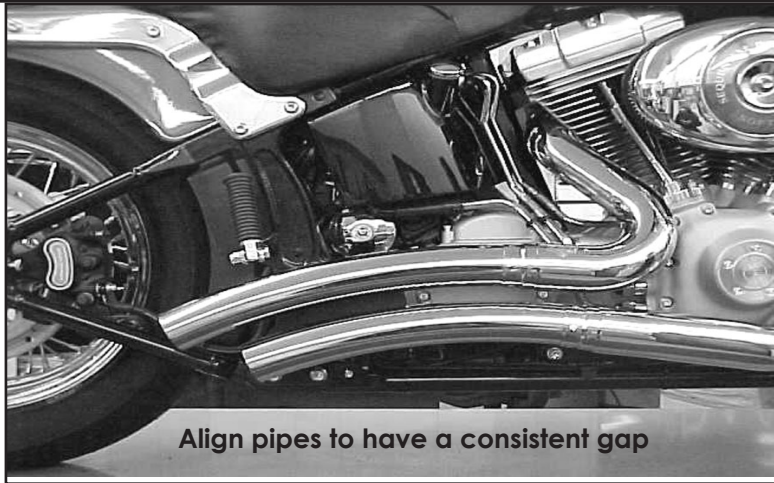

**FIGURE 8**

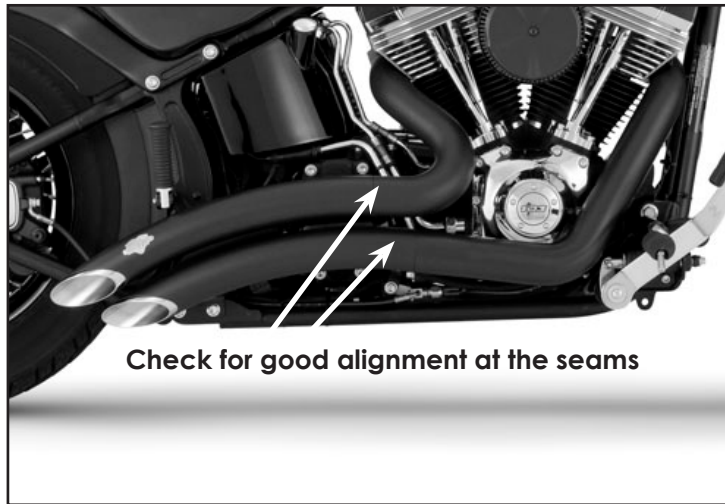

## THE NEXT GENERATION OF FUEL MANAGEMENT IS HERE

The Fuelpak FP3 will revolutionize fuel management for all new Harley-Davidson models now using the HDLAN (CAN Bus) system. Connecting wirelessly by Bluetooth to iPhone or Android Smartphones, Fuelpak FP3 uses Flash technology to recalibrate engine parameters and mapping for Vance & Hines exhaust systems downloaded from the expansive library of calibrations developed by Vance & Hines.

- Smartphone App User Interface (iOS and Android)
- Recalibrates ECM by Flash Tuning
- Autotune Feature for Added Tuning Precision
- Displays Live Sensor Data
- App Links Direct to Customer Service Site

### FITMENT NOTES:

- FUELPK FP3 IS COMPATIBLE WITH CAN BUS MODELS ONLY (TOURING, SOFTAIL, DYNA & SPORTSTER)
- FUELPK FP3 IS NOT COMPATIBLE WITH V-ROD MODELS.
- MAPS ARE CURRENTLY AVAILABLE FOR: SPORTSTER, DYNA, SOFTAIL, TOURING AND TRIKE MODELS.
- MAPS FOR 110CI CVO MODELS COMING SOON.

### EMISSIONS NOTICE:

FUELPK IS INTENDED FOR RACING USE ONLY, AND IS NOT LEGAL FOR SALE OR USE IN CALIFORNIA ON POLLUTION-CONTROLLED VEHICLES.



### Emissions Notice:

In California, in order to meet Air Resources Board emissions requirements, certain aftermarket part applications have been identified as replacements, and others have received ARB Executive Orders. All other emissions related aftermarket parts are for competition use only. A list of replacement parts and EO parts, and corresponding fitment is provided at [vanceandhines.com/California](http://vanceandhines.com/California).

### Warranty:

All Vance & Hines products are warranted against defects in material and workmanship for a period of 90 days. This warranty does not cover discoloration or rust. This warranty shall be limited to the repair or replacement of the product, which may be proven defective under normal use. Vance & Hines will not warranty any system that has been abused, misused, improperly installed or modified.

Dealers or distributors are not authorized to make dispositions binding upon Vance & Hines. Vance & Hines will not be responsible for any labor charges incurred in removing or replacing any system under warranty. A return authorization number and a copy of the original purchase invoice must accompany all returns. Parts returned without a return authorization may be refused.

13861 ROSECRANS AVENUE / SANTA FE SPRINGS, CA 90670  
SALES: (562) 921-5388  
TECHNICAL: (562) 926-5291  
FAX: (562) 802-0110

**vanceandhines**  
**.com**